

INTRABOX

intratone

SECURE AND MANAGE ACCESS POINTS WITH INTRABOX DATA

EVEN
EASIER!

Choose the simplest all inclusive and plug
& play solution for your property

COMMITMENT
FREE

EVERYTHING YOU NEED

SUBSCRIPTION
FREE

A complete pack consisting of:

- * All necessary equipment
- * Service package appropriate for specific type of access

And as always, we include unlimited free updates in real-time via our management portal

HOW DOES IT WORK?

1

ORDER YOUR INTRABOX



2

PROGRAM AND INSTALL EQUIPMENT

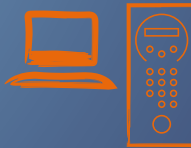

3

READY TO USE RIGHT AWAY



5 ADVANTAGES OF INTRABOX

1. Products suitable for everywhere, without wiring to individual flats
2. Real-time and remote management on www.intratone.info
3. Commitment-free, subscription-free
4. Equipment despatched immediately
5. Best price guarantee

YOU ALSO BENEFIT FROM

4 technical alerts
(with relay cards) to receive alerts in the event of a malfunction (ventilation, pump, open blocked door, etc.)

Log-event reporting
(GDPR compliant)

Service provider alert
to track interventions by your suppliers

Yearly time switch



PAB INTERCOM SYSTEM

Special public access building

INTRABOX

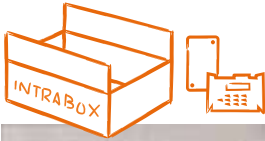

2 button intercom (06-0159)



4 button intercom (06-0161)

INTRABOX PAB video intercom system:

2 or 4 call buttons with proximity reader + audio induction loop - flush mounting - stainless steel finish.

- Accessible for all
- Video reception on Smartphone⁽¹⁾, Tablet⁽¹⁾ and PC⁽²⁾
- Flush mounting with swivel hinge

(1) With the My Intratone Intercom app.
(2) With the My Intratone Intercom Windows software package (compatible with Windows 7, 8 and 10)

10 YEARS
UNLIMITED UPDATES

Video	4G		Remote online management
Accessible for all	Vandal resistant		www.intratone.info

System	
Number of relays	1 (+3)
Connection	
4G transmission module	Yes
4G module characteristics	
Remote module	Yes
Number of intercom systems per transmissions module	1
Access control equipment	
Proximity reader	Yes
Mounting	
Flush mounting	Yes
Swivel hinge	Yes
Finish	
Stainless steel	Yes
Dimensions	
Intercom	150 x 300 x 9mm
Intercom back box	127 x 275 x 45mm

GOOD TO KNOW

With the My Intercom Intratone Windows software package, you can see the visitor on your PC (compatible with Windows 7, 8 and 10)

RANGE

Products

06-0159	Intrabox video intercom system 2 call buttons with proximity reader + audio induction loop + 1 management unit 1 door and/or 200 names (03-0102) + 1 4G transmissions module including remote management and 10-year audio calls - flush mounting - surface mounted box (12-0104) not included - stainless steel finish
06-0161	Intrabox video intercom system 4 call buttons with proximity reader + audio induction loop + 1 management unit 1 door and/or 200 names (03-0102) + 1 4G transmissions module including remote management and 10-year video calls - flush mounting - surface mounted box (12-0104) not included - stainless steel finish

Accessories

12-0108	Rain shield - stainless steel finish (155.5 x 305 x 35mm)
12-0104	Surface mounted box - stainless steel finish (305.5 x 155.5 x 57.5mm)

DON'T FORGET TO ADD
YOUR SERVICE PACKAGE!

PREPAID
10-YEARS ALL
INCLUSIVE PACKAGE

COST[£]_E[£]
EFFECTIVE





CALL CARETAKER

1 to 3 call buttons **EASIER TO USE**

INTRABOX



15 YEARS
UNLIMITED UPDATES

INTRABOX Call Caretaker intercom system:

1 to 3 call buttons + proximity reader (optional) - flush mounting - stainless steel finish.

- ▶ Audio only
- ▶ Up to 3 call buttons
- ▶ Ideal for properties with dedicated caretakers



Audio



4G



Vandal resistant



Remote online management
www.intratone.info

Max. number of homes managed	3
System	
Audio	Yes
Connection	
4G module	Yes
Access control equipment	
Proximity reader	Optional
Mounting	
Flush mounting	Yes
Finish	
Stainless steel	Yes
Dimensions	
Intercom facade	130 x 250 x 3mm
Intercom back box	101 x 220 x 37mm

Functional messages: (call in progress etc.) Speech synthesis
 Sound level adjustment: from the management unit (03-0102)
 Call transfer
 Time slot programming: up to 7 per day and per button

RANGE

Products	
06-0147	Intrabox audio intercom system Call Caretaker 1 call button with proximity reader + 1 door controller for 1 door (03-0102) + 1 4G transmission module – including remote management and audio communications for 15-years – flush mounting – stainless steel finish
06-0146	Intrabox audio intercom system Call Caretaker 1 call button + 1 relay card (12-0110) + 1 3G transmission module – including remote management and audio communications for 15 years – flush mounting – stainless steel finish
06-0148	Intrabox audio intercom system Call Caretaker 2 call buttons + 1 relay card (12-0110) + 3G transmission module – including remote management and audio communications for 15 years – flush mounting – stainless steel finish
06-0150	Intrabox audio intercom system Call Caretaker 1 call button + 1 management unit 1 door and/or 200 names (03-0102) + 1 4G transmissions module - including remote management and 15-year audio calls - video pre-equipped - flush mounting - stainless steel finish
06-0151	Intrabox audio intercom system Call Caretaker 1 call button with proximity reader + 1 management unit 1 door and/or 200 names (03-0102) + 1 4G transmissions module - including remote management and 15-year audio calls - video pre-equipped - flush mounting - stainless steel finish
06-0152	Intrabox audio intercom system Call Caretaker 1 call button + 1 management unit 1 door and/or 200 names (03-0102) + 1 4G transmissions module - including remote management and 15-year audio calls - video pre-equipped - flush mounting - stainless steel finish
06-0153	Intrabox audio intercom system Call Caretaker 1 call button + 1 management unit 1 door and/or 200 names (03-0102) + 1 4G transmissions module - including remote management and 15-year audio calls - video pre-equipped - flush mounting - stainless steel finish
Accessory	
12-0105	Surface mounted box - stainless steel finish (135.5 x 255.5 x 58.5mm)



INTRACALL

1 call button

EASIER TO USE

INTRABOX

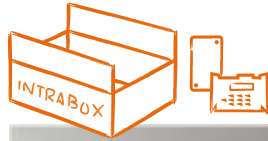

15 YEARS
UNLIMITED UPDATES

INTRABOX Intracall intercom system: 1 call button - flush mounting - stainless steel finish.

- ▶ Easy to install into a post (88mm wide)
- ▶ Program up to 7 different call numbers per day
- ▶ Ideal for securing a car park



Audio



4G



Vandal resistant



Remote online management
www.intratone.info

System	
Audio	Yes
Connection	
4G Intratone module	Yes
Connected to a remote camera	Optional
Mounting	
Flush mounting	Yes
Finish	
Stainless steel	Yes
Dimensions	
Intercom facade	88 x 180 x 4mm
Intercom back box	68 x 160 x 40mm

Speech synthesis - Functional messages: (call in progress etc.)
Sound level adjustment: from the management unit (03-0101)
Call transfer

RANGE

Products

06-0181	Intrabox Intracall 1 call button + 1 door management unit + 4G module with 15-year unlimited prepaid video calls (if using a remote analogue PAL camera). Audio communications only.
06-0182	Intrabox Intracall 1 call button + 1 door management unit + 4G module with 15-year unlimited prepaid video calls (if using a remote analogue PAL camera). Audio and video communications.

Accessory

12-0145	Surface mounted box - stainless steel finish (93 x 185 x 60mm)
---------	--



COMMUNICATING

Key safe

EASIER TO USE

INTRABOX



Electronic key ring tag

INTRABOX Data communicating key safe + 1 proximity reader (04-0104)- flush fit, stainless steel.

- ▶ Control who has access to site keys - and when
- ▶ Allow access with authorised key fobs
- ▶ Stainless steel finish



Accessible for all



Remote online management
www.intratone.info
or organigramme.info

10 YEARS
UNLIMITED UPDATES

SIMPLIFIED SCHEMATIC

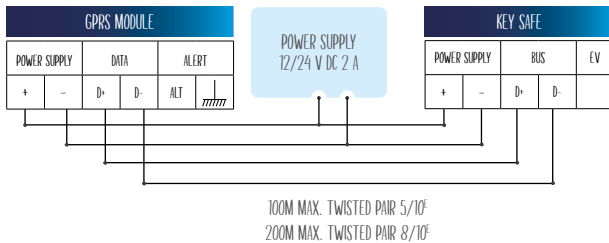

Capacities

Compatible with key fobs and transmitters equipped with MIFARE technology	Yes
Max number of key fobs	3,000
Technical alert (emails)	Yes
Yearly time switch	Yes

Management and alerts

Alert if door is open too long	Yes
Alert / intrusion (strikes to box)	Yes
List of events on the management website	Yes
Alert / key ring tag X removed	Yes
Alert / key ring tag X returned	Yes
Management of mechanical keys and electronic keys (organigramme.info)	Yes

TECHNICAL SPECIFICATIONS

Power supply

Key safe
12/24 V DC 2 A mini

Wiring

Key safe - GPRS module or central unit
2 wires (1 twisted pairs)
Ø 8/10e - Max: 100m

Dimensions (L x H x D)

GPRS module
162 x 96 x 53mm
Key safe back box
126 x 179 x 60mm
Key safe facade
150 x 220 x 2.5mm

Environment

Operating temperature
-20°C to +70°C
Key safe protection index
IP55

RANGE

Products

06-0106 | Intrabox communicating key box: 1 key box (02-0116) + 1 proximity reader (04-0104) + 1 transmissions module with 10-year unlimited data synchronisation - stainless steel finish

Accessory

12-0102 | Surface mounted box - stainless steel finish (155.5 x 225.5 x 71mm)



KEY SAFE

with 1 call button

EASIER TO USE

INTRABOX



Electronic key ring tag

15 YEARS
UNLIMITED UPDATES

INTRABOX Data 1 push button intercom with built-in key box + proximity reader (04-0106) - flush mounting - stainless steel finish.

- ▶ Open safe remotely by calling
- ▶ Real time and remote management of keys
- ▶ Key management via MIFARE electronic key tags



Audio



Data



Vandal resistant



Accessible for all



Remote online management
www.intratone.info
or orgranigramme.info

SIMPLIFIED SCHEMATIC

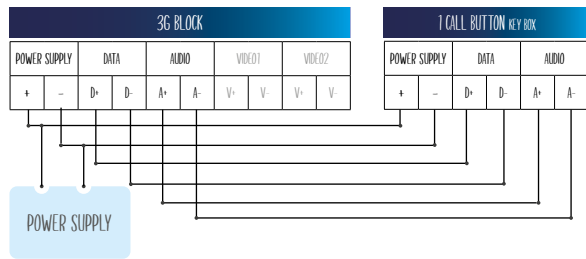

Capacities

Compatible with key fobs and transmitters equipped with MIFARE technology	Yes
Max number of key fobs	500
Number on numbers on time slots	7
Time-dated events	Yes
Door opening (+ 1 relay card 12-0110)	Yes

Opening modes / Key box functions

When making a call, by entering a code on the telephone	Yes
On site, with an authorised key fob or electronic tag if assigned to the key box	Yes

Traceability

Open too long alert equipped with MIFARE technology	Yes
Technical alert: intrusion	Yes
Technical alert: key ring tag X removed	Yes
Technical alert: key ring tag X returned	Yes
List of events on the management website	Yes
Management of mechanical keys and electronic keys (www.intratone.com)	Yes

Dimensions

Key safe facade	180 x 385 x 2.5mm
Key safe back box	156.2 x 359 x 60mm

RANGE

Products

06-0126	Intrabox 1 push button intercom with built-in key box + 1 proximity reader + 1 transmissions module with 15-year unlimited data synchronisation - stainless steel finish
---------	--

Accessory

12-0131	Surface mounted box - stainless steel finish (185.5 x 390.5 x 71mm)
---------	---



INTERACTIVE DIGITAL NOTICEBOARD

Digital communication to residents

INTRABOX



Digital noticeboard: 15-inch screen, for indoors only.

- ▶ Real-time resident information without going on site
- ▶ Communicate unique messages to each noticeboard
- ▶ Scroll buttons and poll function



Vandal resistant



Remote online management
www.intratone.info

Management / updates

Suitable upload file format	PDF, Excel, Word
Max. file size	8 MB

Unlimited updates

From the management website www.intratone.info	Yes
--	-----

Finish

Dark grey	Yes
-----------	-----

Safety

Protection index	IK08
Safety glass	Thickness 10mm

Dimensions

Facade	348 x 525 x 28mm
--------	------------------



PRODUCT ADVANTAGES

INTERACTIVITY: comes with an integrated survey function

TECHNICAL SPECIFICATIONS

Power supply

24 V DC noticeboard
2 A - indoor version
3 A - outdoor version

Wiring

Noticeboard - module
4 wires (2 twisted pairs)
Ø 8/10e - Max: 100m

Environment

Noticeboard indoor version
Operating temperature
-10°C to +45°C
Protection index IP40

Noticeboard outdoor version
Operating temperature
20°C to +70°C
Protection index IP65
Waterproof
Outdoor mounting

RANGE

Products **Digital noticeboard 15-inch screen, to be connected to the intercom system**

06-0208 | 1 digital noticeboard - interactive (11-0107) + 1 transmission module with data, unlimited data synchronisation for 15 years

15 YEARS
UNLIMITED UPDATES



GOOD TO KNOW

On the noticeboard, quick
cover removal: adjust contrast,
reset noticeboard





INTRABOX DATA HANDS-FREE

Hands-free proximity reader

EASIER TO USE

INTRABOX



10 YEARS
UNLIMITED UPDATES

INTRABOX Data Hands-Free: hands-free proximity reader (04-0108-EU) with one door controller (03-0102-EN) + 1 transmission module unlimited data and synchronisation for 10 years (06-0180).

- ▶ Remote opening from 1m away
- ▶ Stainless steel finish



Data



Vandal resistant



Accessible for all



Remote online management

www.intratone.info

TECHNICAL SPECIFICATIONS

Power supply

12/24 V DC 2 A mini

Wiring

Central unit - reader

4 wires (2 twisted pairs)

Ø 8/10e - Max: 100m

Central unit - GPRS module

4 wires (2 twisted pair)

Ø 8/10e - Max: 200m

Dimensions (L X H X D)

Reader 130 x 130 x 40mm

Central unit 74 x 59 x 18mm

GPRS module 162 x 96 x 53mm

Environment

Operating temperature

-20°C to +70°C

Reader protection index

IP54

Functions

Open access slots	Yes
Log events	Yes
Compatible with key fobs and remote transmitters equipped with MIFARE technology	Yes
Maximum number of key fobs	3,000
Technical alert	Yes
Yearly time switch	Yes

SIMPLIFIED SCHEMATIC

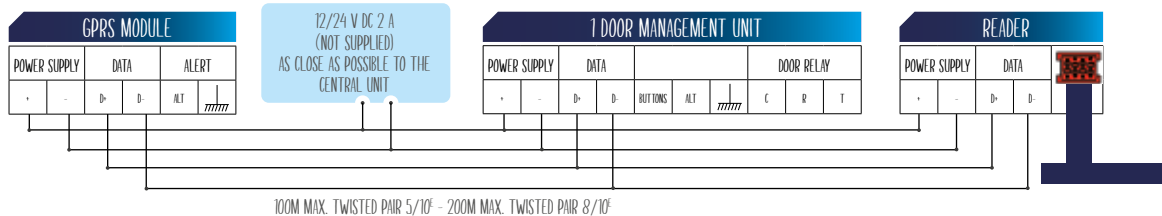

RANGE

Products

06-0180 | Intrabox hands-free proximity reader (04-0108-EU) with one door controller (03-0102-EN) + 1 transmission module unlimited data and synchronisation for 10 years

Accessory

12-0158 | Surface mounted box - stainless steel finish





INTRABOX DATA PROX

Secure access control

INTRABOX



INTRABOX Data Prox: 1 flush fit square proximity reader (04-0106) + 1 relay card (12-0110) + 1 transmission module unlimited data and syncing for 10 years (06-0131).

- No need for a programmer
- Create, change or delete key fobs without recovering them
- Stainless steel finish

SQUARE PROXIMITY READER 04-0106



Data



Vandal resistant



Accessible for all



Remote online management

www.intratone.info

NO NEED FOR A PROGRAMMER

Functions	
Free access time slots	Yes
Log events	Yes
Compatible with key fobs and remote transmitters equipped with MIFARE technology	Yes
Maximum number of key fobs / master key fobs	10,000
Technical alerts (emails)	✓

TECHNICAL SPECIFICATIONS

Power supply

min. 12/24 V DC - 2 A

Wiring

Relay card - reader
4 wires (2 twisted pairs)
Ø 8/10e - Max: 200m
Relay card - GPRS unit
4 wires (2 twisted pair)
Ø 8/10e - Max: 200m

Dimensions (L x H x D)

Reader 32 x 42 x 18mm
Relay card 74 x 59 x 18mm
GPRS unit 162 x 96 x 53mm
Read head (with cover)
64.5 x 62 x 23mm
Read head only Ø 40 x 40mm
Reader (bare) 62 x 62 x 23mm

Environment

Reader operating temperature
-20°C to +70°C
Reader storage temperature
-20°C to +70°C
Reader protection class IP50

SIMPLIFIED SCHEMATIC

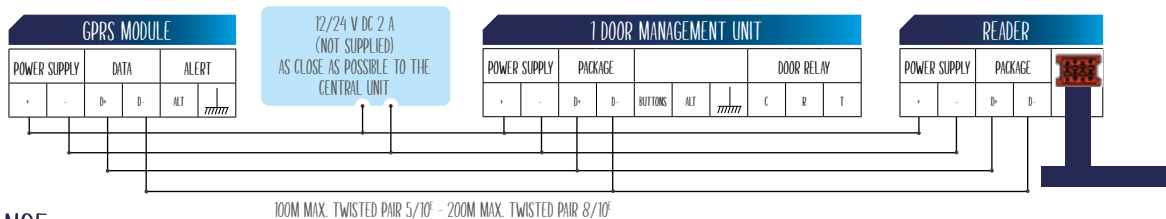

RANGE

Products

06-0143	Intrabox Data Prox: 2 flush fit square proximity readers (04-0106) + 2 door controller for 2 doors (03-0101) + 1 transmission module unlimited data and syncing for 10 years
06-0131	Intrabox Data Prox: 1 flush fit square proximity reader (04-0106) + 1 relay card (12-0110) + 1 transmission module unlimited data and syncing for 10 years

Accessory

12-0132	Surface mounted box for square reader - surface mounted - stainless steel finish (125.5 x 125.5 x 57mm)
12-0135	Box for square reader - flush-fit - stainless steel finish (90.4 x 90 x 37mm)



INTRABOX DATA MINI

Built-in HF receiver

EASIER TO USE

INTRABOX

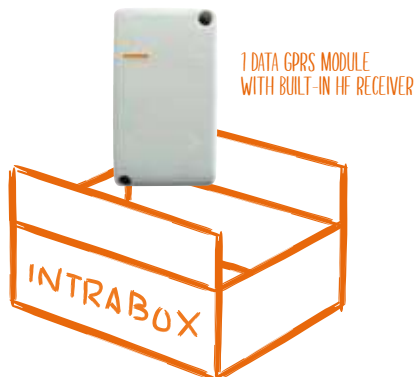

REAL-TIME MANAGEMENT

10 YEARS UNLIMITED UPDATES



GOOD TO KNOW

You can add one or two mini coded keypads to this system (Intrabox 06-0130)



INTRABOX Data Mini HF: 1 transmission module with built-in HF receiver with 10-years of unlimited data syncing and updates (06-0129).

- ▶ For real-time and remote management of car park access
- ▶ Create, change or delete a transmitter without having to recover it



Data



Vandal resistant



Remote online management
www.intratone.info

Capacities

Max number of accesses managed	2
Open access time slots	Yes
Yearly time switch	Yes
Permanent rolling code	Yes
Max number of transmitters	10,000
Max number of codes (with coded keypad)	80

SIMPLIFIED SCHEMATIC

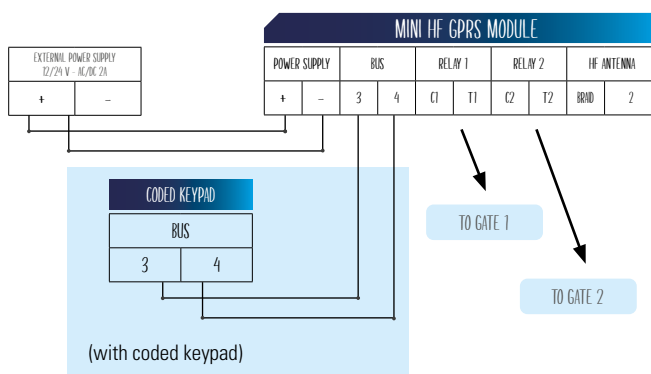

TECHNICAL SPECIFICATIONS

Power supply

12/24 V AC/DC 1 A mini

Dimensions (L x H x D)

GPRS module
162 x 96 x 53mm
Keypad 85 x 137 x 16mm

Wiring

GPRS module - 1 coded keypad
2 wires (1 twisted pair)
Ø 8/10e - Max: 100m

Environment

Operating temperature
-20°C to +60°C
Protection index IP55

RANGE

Products

06-0129	Intrabox Data Mini HF: 1 transmission module with built-in HF receiver and unlimited data and syncing for 10 years
06-0130	Intrabox Data Mini HF: 1 transmission module with built-in HF receiver + 12-digit backlit mini coded keypad (04-0107) – unlimited data and syncing for 10 years



INTRABOX DATA

868 MHz HF receiver

EASIER TO USE

INTRABOX

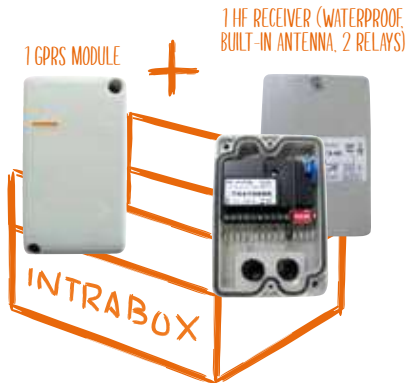

INTRABOX Data HF: 1 HF receiver with built-in antenna + 1 transmission module with 10-years of unlimited data syncing and updates (06-0101).

- ▶ Control an underground car park entrance
- ▶ Create, change or delete a transmitter without having to collect it
- ▶ No need for a programmer

REAL-TIME MANAGEMENT

10 YEARS UNLIMITED UPDATES



Data



Vandal resistant



Accessible for all



Remote online management
www.intratone.info

SIMPLIFIED SCHEMATIC

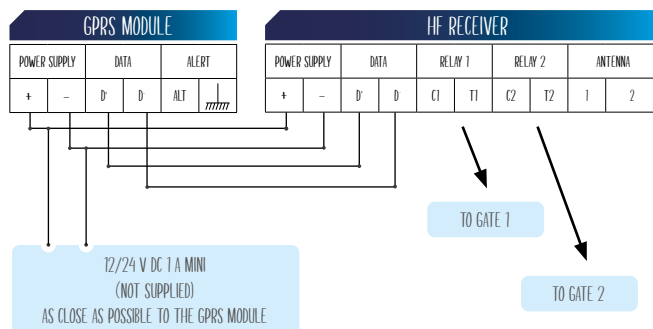

TECHNICAL SPECIFICATIONS

Power supply
12/24 V DC 1 A mini

Wiring
Receiver - GPRS module
4 wires (2 twisted pairs)
Ø 8/10e - Max: 100m

Dimensions (L x H x D)
GPRS module 162 x 96 x 53mm
Receiver 90 x 129 x 37mm

Environment
Operating temperature -20°C to +70°C
Protection index IP67

Capacities

Max number of accesses managed	2
Open access slots	Yes
Time-dated events	Yes
Anti-passback	No
Vehicle presence	No
Rolling code	Yes
Technical alert (emails)	Yes
Max number of transmitters*	10,000
Yearly time switch	Yes

Installation

Outdoor mounting (thanks to its waterproof case)	Yes
--	-----

ATTENTION, no 2nd antenna possible
* 1 4-button transmitter (09-0115) opens up to 4 accesses

RANGE

Products

06-0101 | Intrabox Data HF: HF receiver with built-in antenna (07-0106) + 1 transmission module, unlimited data synchronisation for 10 years





CODED KEYPAD

Built-in HF receiver

EASIER TO USE

INTRABOX



WITH READER OR WITH PUSH BUTTON

INTRABOX Coded keypad with 12-button backlit coded keypad + push button or proximity reader.

- ▶ Control an isolated door
- ▶ Create, change or delete codes or key fobs remotely
- ▶ No need for a programmer



Data



Vandal resistant



Remote online management
www.intratone.info

10 YEARS UNLIMITED UPDATES

TECHNICAL SPECIFICATIONS

Power supply

12/24 V DC 2 A mini

Wiring

Central unit or relay card - keypad

4 wires (2 twisted pairs)

Ø 8/10e - Max: 100m

Central unit or relay card - GPRS module

4 wires (2 twisted pair)

Ø 8/10e - Max: 100m

Dimensions (L x H x D)

Keypad 120 X 190 X 25mm

Central unit or relay card

74 x 59 x 18mm

GPRS module 162 x 96 x 53mm

Environment

Operating temperature

-20°C to +70°C

Keypad protection index IP55

Reader protection index IP50

Coded keypad + reader

Coded keypad Push button

Capacities

	Coded keypad + reader	Coded keypad Push button
Max number of accesses managed	1	1
Number of keypad codes	40	80*
Open access slots	Yes	Yes
Time-dated events	Yes	Yes
Compatible with key fobs and transmitters equipped with MIFARE technology	Yes	No
Technical alert (emails)	Yes	Yes
Max number of key fobs	3,000	No
Yearly time switch	Yes	Yes

*80 codes due to the use of a relay card

SIMPLIFIED SCHEMATIC

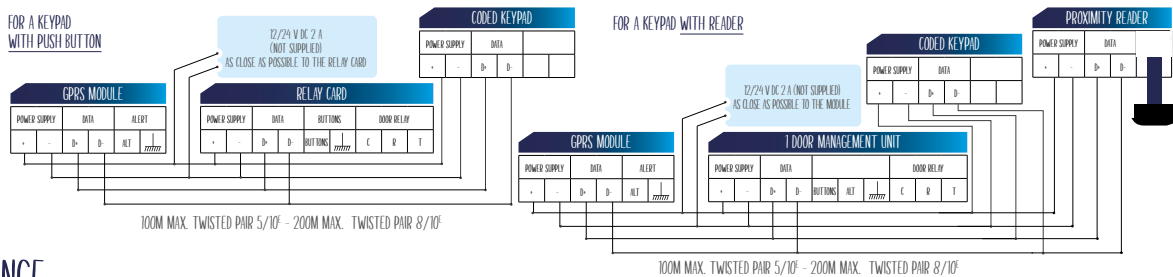

RANGE

Products

06-0103	Intratone coded keypad: 12 digit backlit coded keypad with push button (04-0101) + 1 relay card (12-0110)
06-0104	Intratone coded keypad: proximity reader (04-0104) + door controller for 1 door (03-0102) + 1 transmission module unlimited data and synchronisation for 10 years

Accessory

12-0103	Surface mounted box - stainless steel finish
---------	--